

# ARMORGUARD® BARRIER

NCHRP 350 TL-3 Permanent Steel Barrier Gate  
1823790 - Installation and Maintenance Manual

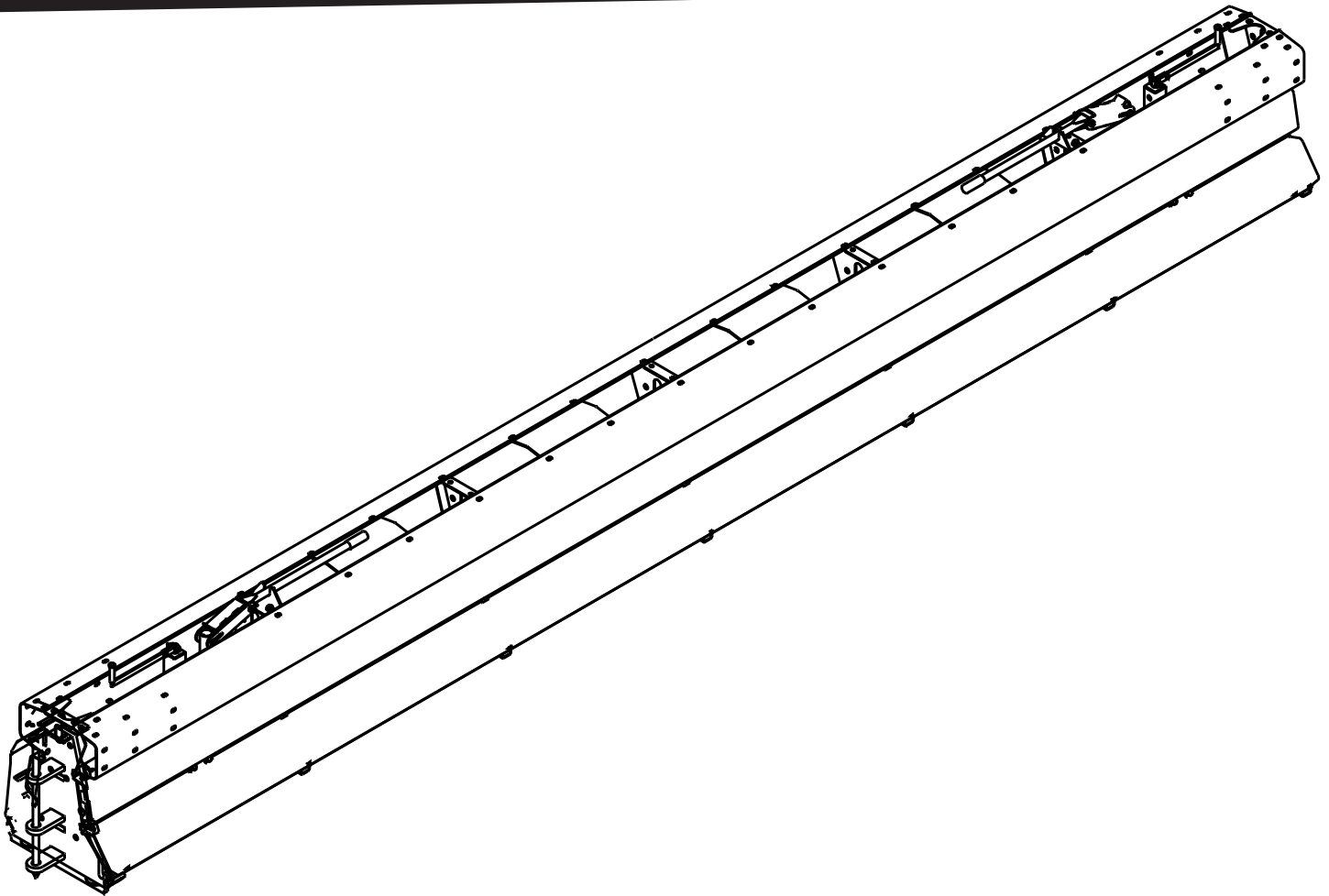

***BARRIER SYSTEMS***<sup>™</sup>  
BY LINDSAY



## Installation and Maintenance Manual Supplement ARMORGUARD® BARRIER

Preface	
Introduction	
Warranty	
System Overview	
Required Tools	
Section Splicing Instructions	
Transition Installation Instruction	
Limitations and Warnings	
<b>Appendix</b>	
A. Anchoring Material Options	
B. Anchoring Foundation and Barrier Cutout	
C. System Assembly Drawings	
D. Maintenance	

<b>2</b>	<b>PREFACE</b>
2	The ArmorGuard Gate System (AGG), incorporates the newest roadside safety materials and engineering processes.
3	
4	As with any roadside safety device, the AGG must be installed properly to insure proper performance.
4	
5	Thoroughly review and fully understand the installation instructions and product limitations before starting the installation. An instructional video is available from BSI to help explain the general installation requirements. Watch and fully understand the AGG Section Splice and Hinge / Transition Installation and Assembly Video before attempting to install the system. Do not start the installation without the proper plans and tools required for installation. If you need additional information, or have questions about the ArmorGuard Gate System, please call the Lindsay Transportation Solutions Sales and Services, Inc Customer Service Department at (888) 800-3691 (U.S toll free) or (707) 374-6800.
9	
15	
16	
17	
19	
27	

## INTRODUCTION

The AGG has been fully tested in accordance with the evaluation parameters in NCHRP Report 350, Test Levels 3 (100 km/hr).

The system is a heavily reinforced steel barrier that is designed for emergency openings. It is ideally suited for permanent and stationary work zone barriers where emergency vehicles, maintenance crews and emergency evacuation access may be needed and positive barrier protection is required.

The system should be installed on a smooth firm surface that is capable of supporting the weight of the system. Generally a Portland Concrete Cement (PCC) surface is preferred but the system has been successfully installed and used on an Asphaltic Concrete surface. Please refer to Appendix B.



---

**STANDARD LIMITED WARRANTY**

Lindsay Transportation Solutions, Inc. "LTS" ( formerly Barrier Systems ) has tested the impact performance of its barriers and crash cushion systems, and other highway safety hardware under controlled conditions, however, LTS does not represent nor warrant that the results of those controlled conditions would necessarily avoid injury to persons or property. LTS EXPRESSLY DISCLAIMS ANY WARRANTY OR LIABILITY FOR CLAIMS ARISING BY REASONS OF DEATH OR PERSONAL INJURY OR DAMAGE TO PROPERTY RESULTING FROM ANY IMPACT, COLLISION OR HARMFUL CONTACT WITH THE PRODUCTS OR NEARBY HAZARDS OR OBJECTS BY ANY VEHICLE, OBJECTS OR PERSONS.

LTS warrants that any product or component part manufactured by LTS will be free from defects in material or workmanship. LTS will replace free of cost any Product or component part manufactured by LTS that contains such a defect.

THE FOREGOING WARRANTY IS IN LIEU OF AND EXCLUDES ALL OTHER WARRANTIES NOT EXPRESSLY SET FORTH HEREIN, WHETHER EXPRESS OR IMPLIED BY OPERATION OF LAW OR OTHERWISE, INCLUDING BUT NOT LIMITED TO ANY IMPLIED WARRANTIES OF MERCHANTABILITY OR FITNESS FOR A PARTICULAR PURPOSE.

LTS' LIABILITY UNDER THIS WARRANTY IS EXPRESSLY LIMITED TO REPLACEMENT FREE OF COST (IN THE FORM AND UNDER THE TERMS ORIGINALLY SHIPPED), OR TO REPAIR OR TO MANUFACTURE BY LTS, PRODUCTS OR PARTS NOT COMPLYING WITH LTS SPECIFICATIONS, OR, AT LTS' ELECTION, TO THE REPAYMENT OF AN AMOUNT EQUAL TO THE PURCHASE PRICE OF SUCH PRODUCTS OR PARTS, WHETHER SUCH CLAIMS ARE FOR BREACH OF WARRANTY OR NEGLIGENCE. LTS SHALL NOT BE LIABLE FOR ANY INCIDENTAL, CONSEQUENTIAL OR SPECIAL LOSSES, DAMAGES OR EXPENSES OF ANY KIND, INCLUDING, WITHOUT LIMITATION, ANY SUCH LOSSES, DAMAGES OR EXPENSES ARISING DIRECTLY OR INDIRECTLY FROM THE SALE, HANDLING OR USE OF THE PRODUCTS FROM ANY OTHER CAUSE RELATING THERETO, OR FROM PERSONAL INJURY OR LOSS OF PROFIT.

Any claim by the Buyer with reference to Products sold hereunder for any cause shall be deemed waived by the Buyer unless LTS is notified in writing, in the case of defects apparent on visual inspection, within ninety (90) days from the delivery date, or, in the case of defects not apparent on visual inspection, within twelve (12) months from the said delivery date. Products claimed to be defective may be returned prepaid to LTS' plant for inspection in accordance with return shipping instructions that LTS shall furnish to the Buyer forthwith upon receipt of the Buyer's notice of claim. If the claim is established, LTS will reimburse that Buyer for all carriage costs incurred hereunder.

The forgoing warranty benefits shall not apply to (i) any Products that have been subject to improper storage, accident, misuse or unauthorized alterations, or that have not been installed, operated and maintained in accordance with approved procedures and (ii) any components manufactured by the Buyer.

## SYSTEM OVERVIEW

Longitudinal barriers are highway safety devices whose primary functions are to prevent vehicular penetration and to safely redirect an errant vehicle away from roadside or median hazards. The ArmorGuard Gate system is used as a moveable longitudinal barrier section that can be installed in openings of rigid barrier systems. The system is hinged at both ends and uses a manual jack system to raise the gate section onto casters. This enables the system to be unhinged and swung open from either end, or the whole gate section can be disconnected at both ends and moved in any direction. The purpose of the system is to create a crashworthy closure for rigid longitudinal barrier openings that is capable of being opened by no more than two people in less than 5 minutes.

The system is approximately 28 inches (700 mm) wide and is 33 inches (830 mm) high. It is available in 4-meter (13') increments from 8 meters to 16 meters (26 to 52 feet) in length. The system can be quickly and easily opened or closed without expensive electrical power supplies or sophisticated control systems. Positive security can also be provided.

## REQUIRED TOOLS

- 1/2" (12 mm) medium depth sockets
- 1/2" (12 mm) Ratchet with extensions
- Rotomhammer for drilling holes in concrete
- Torque wrenches
- Measuring tape
- Safety Equipment: Glasses, Gloves
- 1/2" (12 mm) Air impact wrench w/ sockets

**Note: The tools list above is a general recommendation. Depending on the specific characteristics of the job site, different tools may be necessary.**

## BEFORE INSTALLATION

Placement and use of the ArmorGuard Gate System should be accomplished in accordance with the guidelines and recommendations set forth in the "AASHTO Roadside Design Guide," FHWA memoranda and other state and local standards. The AGG is a highly engineered safety device made up of a relatively small number of parts. Before starting the assembly, become

familiar with the basic elements that make up the system. Depending on the size of the system ordered, the gate sections will be shipped separately and the transition parts will be shipped on pallets. Assembly of the system is typically done at the worksite. (If preferred, the system can be assembled "off-site" and set into position as one piece, with a forklift or crane.)

8 and 12 meter gates are shipped fully assembled. 16 meter gates are shipped in (2) 8-meter sections with transitions on pallets.

Before beginning the assembly of the system, check the packing list to be certain that all of the system components were included in the shipment.

**NOTE: It is important to determine the system's installation position to optimize proper function and transition.**

## SECTION SPLICING INSTRUCTIONS

Depending on the length of the system ordered, the gate sections may need to be spliced together. The first part of this manual describes the process for splicing two AGG sections together. This procedure can also be used to replace a damaged 4-meter section.

**The transition to permanent concrete barrier hardware installation instructions start on page 9.**

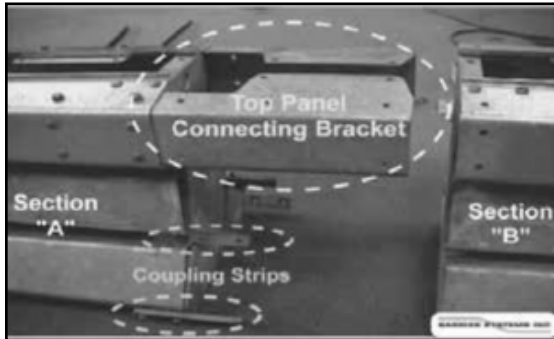

Figure 1.

For the sake of this manual, we will assume that two sections have been delivered and laid out in this orientation with the section on the left labeled Section "A" and the one on the right as Section "B". The Top Panel Connecting Brackets are already installed on Section "A". This manual will show you how to splice the two sections together with the Top Panel Connecting Bracket.



Figure 2.

### Step 1

Remove the Coupling Straps from both sides of Section "A". Use an impact wrench to remove the middle and upper Coupling Straps. Use a wrench or socket to remove the bottom coupling Strap. The bolts that attach the Side Coupling Straps screw into the Threaded Backing Plate (fig 3.) located on the inside of the assembly.



Figure 3.

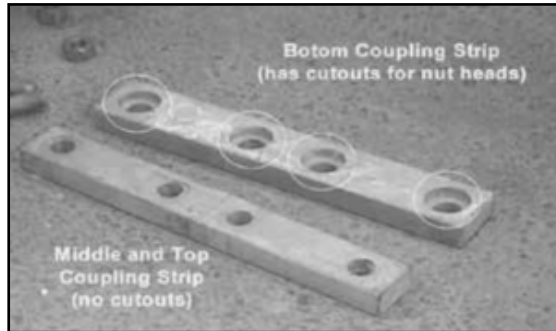

Figure 4.

Notice (Fig 4.) that the Bottom Coupling Straps are different from the Side Coupling Straps as the areas around the holes are cut out so that the Strap can be installed flush over the panel mounting nuts.

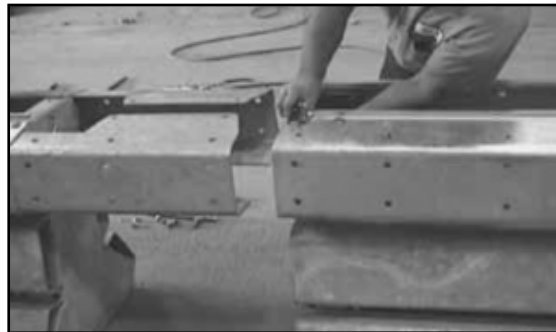

Figure 5.

### Step 2

Remove any bolts in the Top Panel of Section "B". Insert a pry bar into adjacent holes to move the panels around so that the bolts can be easily removed.

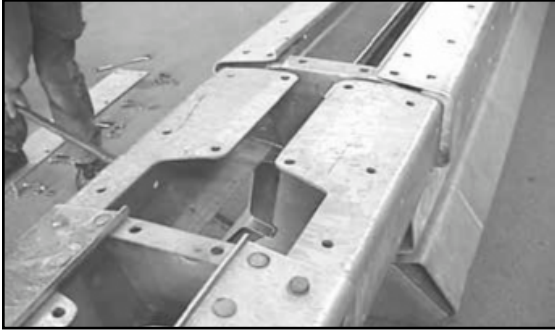

Figure 6

## Step 1

Once all of the bolts on the Section "B" Top Panel are removed, you are ready to insert the Top Panel Connecting Bracket under the top panels of Section "B".

Use a pry-bar (figure 6) to make sure that the unit is aligned and that the top panel on Section "B" will go over the connecting hardware.



Figure 7

**NOTE: Before pushing on the end of Section "B", place a spacer block on the hinge assembly (figure 7). This will prevent the forklift or other pushing device from contacting and possibly damaging the hinge bars.**



Figure 8

## Step 4

Push on the end of Section "B" moving the Top Panels over the Top Panel Connecting Bracket on Section "A". (figure 8.) describes the process for splicing two AGG sections together. This procedure can also be used to replace a damaged 4-meter section.



Figure 9

## Step 5

Use a pry bar to align the side panels so that the Bottom Coupling Strap can be re-installed. Make sure that the Bottom Coupling Strap is used and that the cutouts fit over the nut heads on the outside of the unit. Install the washers and nuts and tighten to 70 ft-lbs (95 N-m).





Figure 10

### Step 6

Install the Side Coupling Straps. One person must hold the Threaded Backing Plate on the inside on the unit, while the other person threads the bolt thru the Side Coupling Strap, the End Cap, and then into the Coupling Strap Nut.

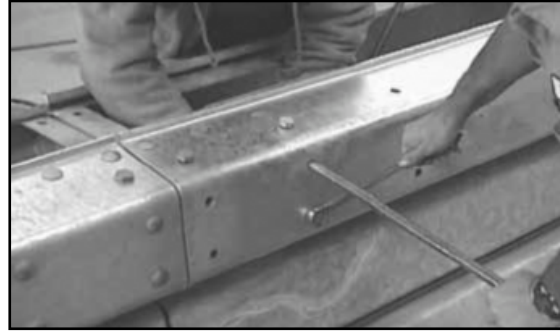

Figure 12

### Step 8

Occasionally after the top bolts have been installed on the Top Panel, the side of the Top Panel will pull away from the assembly. Use a longer hex bolt to temporarily pull the side of the panel in. Install the hex bolt. Keep the holes aligned with the pry bar while tightening (figure 12).

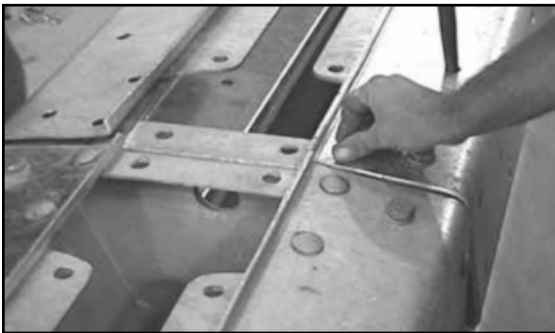

Figure 11

### Step 7

Use a pry bar to align the holes on the Top Panel and reinstall the bolts (figure 11.). Refer to drawing #B010343 in the Appendix C (Page 26) to determine the position of the round head bolts and the hex head bolts.

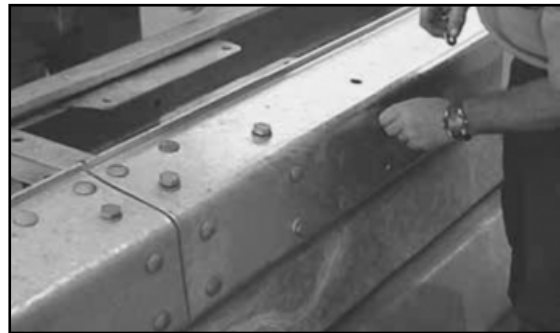

Figure 13

### Step 9

Replace the rest of the side bolts. When all of the side bolts have been replaced, remove the hex bolt and replace it with a Round Head bolt.

The Round Head bolts will eliminate any vehicle snagging if the system is impacted.

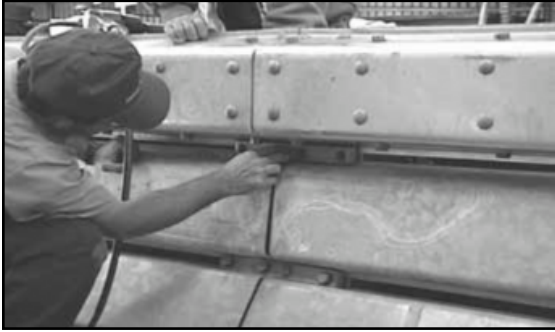

Figure 14

## Step 10

Finish attaching the top panel by installing the bolts on the bottom side of the Top Panel.



Figure 15

## Step 11

Use and impact wrench to tighten all of the side Coupling Strap bolts (figure 15).

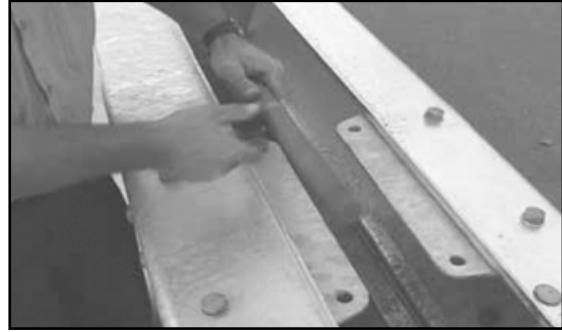

Figure 16

## Step 12

Next, install the Middle Panel Connecting Rods (figure 16). These rods connect the Middle Panels of adjacent 4-meter sections. Install the washer and nut, and tighten with an impact wrench.



Figure 17

## Step 13

Once the Middle Panel Connecting Rods have been installed, the Coupling Shear Plate can be installed. The Coupling Shear Plate attaches across the tops of the two sections (figure 17). Tighten all of the bolts with an impact wrench.



## TRANSITION INSTALLATION INSTRUCTIONS

The transition hardware for the ArmorGuard Gate System (AGG) will be delivered on pallets along with the gate. When requested, and shipping conditions allow, the transition will be shipped partially assembled.

These are the procedures for installing a AGG transition to a permanent concrete safety shaped barrier. The transition hardware consists of a number of parts that must be installed onto the permanent barrier in a particular sequence.

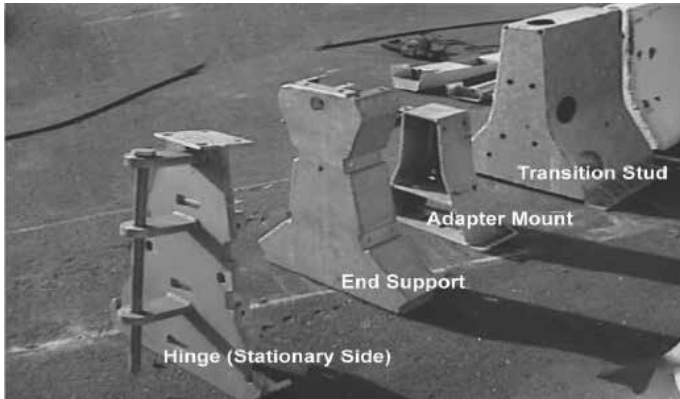

This is a view of the major components that make up the AGG transition to permanent concrete barrier. The components are shown above and to the right.

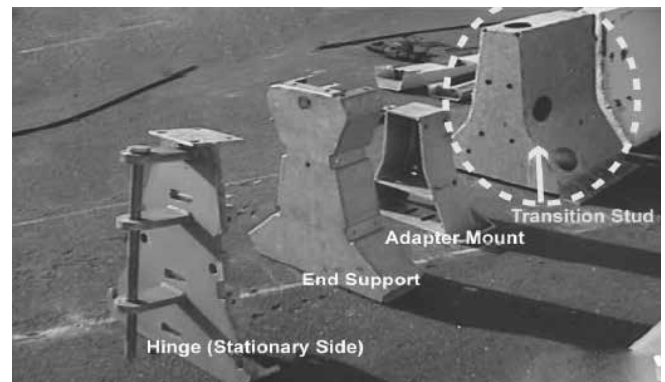
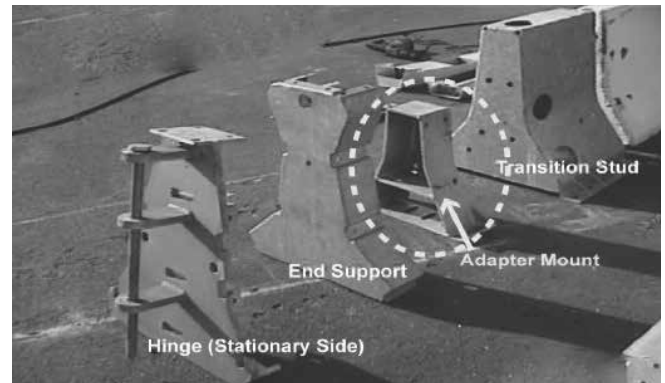
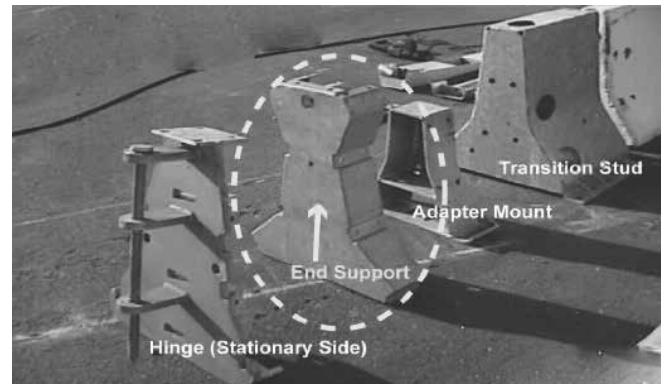
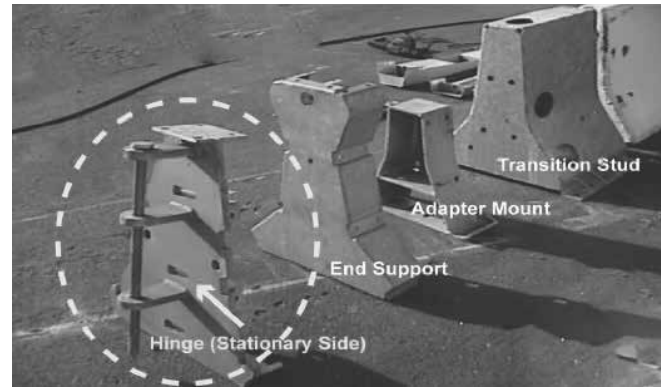



Figure 26.

### Step 1

Slide the Transition Housing over the end of the permanent barrier. A pry bar should easily move the part into place. A forklift could also be used to push the part into place. Center the Gate and transitions within the pre-determined opening, as described in Drawing B011025 (page 18).



Figure 27.

### Step 2

Use the holes in the Transition Housing as a template for marking the position of the anchor holes that will be drilled. Also, mark the holes at the base of the Transition Housing.



Figure 28.

### Step 3

Drill the holes for the Transition Housing side and bottom (Figure 28).

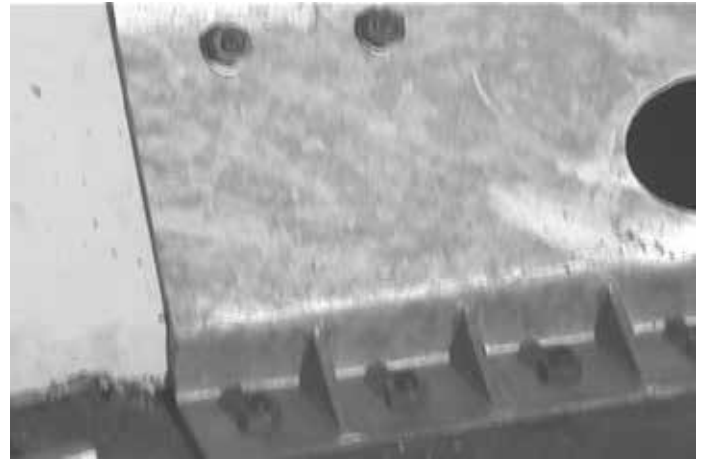

Figure 30.

### Step 4

Insert the enclosed threaded rods into the holes and epoxy in place as directed by instructions enclosed with the epoxy.



Figure 31.

### Step 5

After the anchor epoxy has properly cured, place the washer and nuts on the Housings and tighten. Torque to 120 ft/lbs.



Figure 33.

### Step 7

Install the bolts that hold the Adapter Plate against the Transition Housing by inserting the washers and bolts. Use the access holes on the side of the Transition Housing to install the nuts and lock washers on the bolts. Use the access hole to hold a back-up on the nuts while the bolts are tightened with an impact wrench.



Figure 32.

### Step 6

Install the Adapter Mount assembly over the Housings coming up through the top of the Spacer Plate and against the Transition Housing. Make sure that the Housings that come up through the Spacer Plate are aligned so that they come up through the bottom plate of the Adapter Mount.



Figure 34.

### Step 8

Install the nuts and washers onto the Housings that come up through the Spacer Plate and through the bottom of the Adapter Plate.



Figure 35.

### Step 9

Install the End Support over the Adapter Mount. The End Support will slide over and around the adapter.



Figure 37.

### Step 11

Follow the same steps to install the middle panel. (The middle panel is different from the bottom panel in that it has an insert. The insert will be used to connect a thru-rod later in the process).



Figure 36.

### Step 10

Install the nuts and washers onto the Housings that come up through the Spacer Plate and through the bottom of the Adapter Plate.

At this point, start attaching the side transition panels that run back from the Hinge back onto the concrete barrier. Install the bottom panel first. One person has to hold the panel in place while another person installs the Bottom Coupling Strap. The bolts thread directly into the sides of the End Support.



Figure 38.

### Step 12

Finally the top rail is installed. It is easiest if two people hold the top rail in place while the third person installs the bolts.



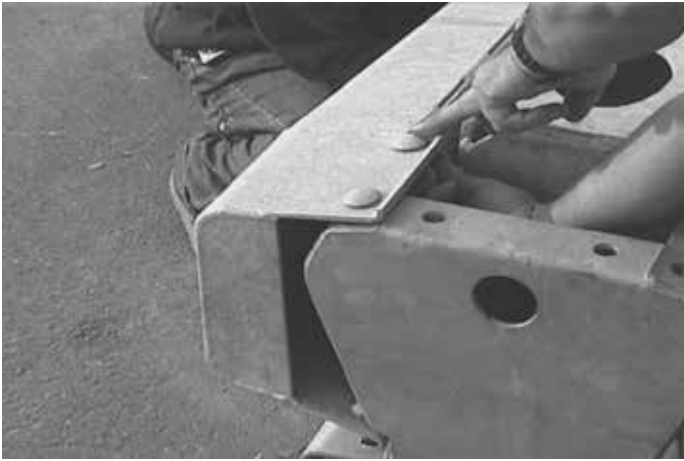

Figure 39.



Figure 41.

### Step 13

Install the two Round Head bolts in the top side of the Top Panel and hand tighten the nuts.

### Step 15

Next install the Hinge Assembly. Slide the tabs on the Hinge Assembly inside the Coupling Straps (see Fig. 41 and 42)



Figure 40.

### Step 14

Install the Top Coupling Strap between the middle and top panel. DON'T TIGHTEN any of the coupling Strap bolts at this time.



Figure 42.



Figure 43.

### Step 16

Install and tighten the bolts that attach the lower, (Figure 42) middle and top (Figure 43) coupling Straps to the Hinge Assembly.



Figure 45.

### Step 18

Drill the holes through the transition panels into the permanent concrete barrier. Insert the Housings into the holes and epoxy in place. After the epoxy has properly cured, install the nuts and washers and torque to 120 ft-lbs (160 N-m).



Figure 44.

### Step 17

Thread the Middle Panel Thru Rod into the Middle Transition Panel until 2 nut lengths of thread extend beyond the flange of the Hinge Assembly. Install the nut and washer and tighten with a torque wrench.



## Limitations and Warnings

The ArmorGuard Gate system has been rigorously tested and evaluated per the recommendations in the NCHRP Report 350 Guidelines for Test Level 3 (TL-3) longitudinal barriers. The impact conditions recommended in NCHRP 350 are intended to address typical in-service collisions.

When the ArmorGuard Gate system is properly installed and maintained, the system is capable of redirecting impacting vehicles in a predictable and safe manner under the NCHRP 350 impact conditions of:

Vehicles: Pickup (2000P) and small car (820C)

Mass: 4400 lbs. (2000 kg) & 1800 lbs. (820 kg)

Speed: 62 mph (100 km/hr)

Angle: 25 degrees for pickup and 20 degrees for small car

Vehicle impacts that vary from the NCHRP 350 impact conditions described for longitudinal barriers may result in significantly different results than those experienced in testing. Vehicle impact characteristics different than or in excess of those encountered in NCHRP 350 testing (speed and angle) may result in system performance that may not meet the NCHRP 350 evaluation criteria.

## APPENDIX A Anchoring Material Options

The anchoring package supplied with the ArmorGuard Gate system contains the necessary threaded rods and epoxy needed to install the system. (Fosroc Anchorite Polyester Epoxy and galvanized or stainless steel threaded rods 3/4" (20 mm) cut to length.) The epoxy has the following physical properties:

**Compressive Strength, ASTM C-109 (7 days):**  
14,000 psi (97 MPa)

**Tensile Strength, ASTM C-307 (7days):**  
2,000 psi (14 MPa)

**Heat Distortion, Temperature, ASTM D-648:**  
233°F (112°C)

**Coefficient of Linear Expansion:**  
 $2.55 \times 10^{-5}/^{\circ}\text{C}$

The proper ratio of filler/hardener to **resin** is two parts of filler/hardener to one part resin by volume.

Anchor bolt holes should be drilled using air-flushed or water-flushed rotary percussive drilling equipment. If diamond core or non-percussive drills are used, the hole must be thoroughly scoured using a coarse wire flue brush.

Other anchoring materials can be used if they comply with the following specifications: epoxy should meet the ASTM C307 tensile strength of 2,000 psi (14 MPa) and compressive strength of 10,000 psi (70 MPa) per ASTM C109 or C579. The anchoring compound (epoxy) should provide a pull out strength of 20,000 lb. (9070 kg) minimum in 4,000 psi (28 MPa) concrete. Products such as HILTI HIT HY150 injection Adhesive Anchor or HVA Adhesive Anchoring System fit this criteria.

If mechanical expansion anchors are provided with the P.C.B. anchoring package, they can be replaced with any corrosion resistant mechanical or chemical anchor that provides a shear capacity of at least 30,000 lb. (13607 KG) and a tensile capacity of at least 20,000 lb. (9070 KG), in 4,000 psi (28MPa) concrete. Appropriate sized threaded rod and specified epoxy can also be substituted.

### For additional information regarding this product, please contact:

Lindsay Transportation Solutions Sales and Services, Inc.  
180 River Road  
Rio Vista, CA 94571

U.S. Toll Free (888) 800-3691  
Phone: (707) 374-6800  
Fax: (707) 374-6801

## **APPENDIX B**

### **Anchoring Foundation and Barrier Cutout**

Placement and installation of the ArmorGuard Gate system must be accomplished in accordance with the guidelines and recommendations set forth in the "AASHTO Roadside Design Guide," FHWA memoranda and other state and local standards.

Foundation Detail,  
Transition to New Jersey Shaped P.C.B.  
Drawing # B011025 ..... **Page 18**

**For additional information regarding this product, please contact:**

Lindsay Transportation Solutions Sales and Services, Inc.  
Customer Service Department  
180 River Road  
Rio Vista, CA 94571

U.S. Toll Free (888) 800-3691  
Phone: (707) 374-6800  
Fax: (707) 374-6801

# INSTALLATION AND MAINTENANCE MANUAL

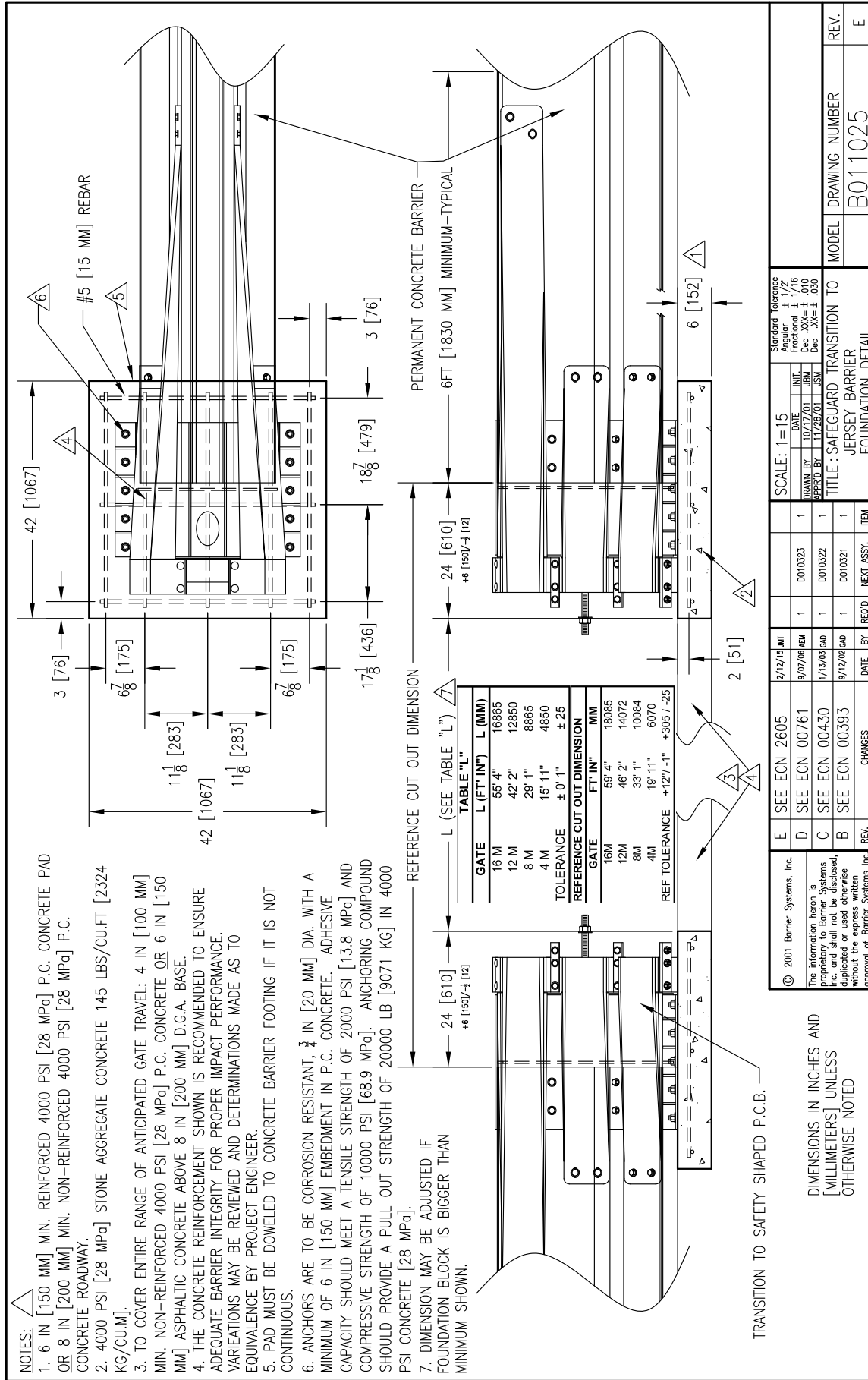

## **APPENDIX C**

### **System Assembly Drawings**

Placement and installation of the ArmorGuard Gate system must be accomplished in accordance with the guidelines and recommendations set forth in the "AASHTO Roadside Design Guide," FHWA memoranda and other state and local standards.

16-Meter Manual Assembly Drawing # 16AGMSAG1	Page 20
12-Meter Manual Assembly Drawing # 12AGMSAG1	Page 21
8-Meter Manual Assembly Drawing # 08AGMSAG1	Page 22
Hinge Mount Set Drawing # B010342	Page 23
Coupling Set Drawing # B010343	Page 24
Transition to New Jersey Shaped Barrier Assembly Drawing # B010406	Page 25
Assembled Transition	Page 26

### **For additional information regarding this product, please contact:**

Lindsay Transportation Solutions Sales  
and Services, Inc.  
Customer Service Department  
180 River Road  
Rio Vista, CA 94571

U.S. Toll Free (888) 800-3691  
Phone: (707) 374-6800  
Fax: (707) 374-6801

# INSTALLATION AND MAINTENANCE MANUAL

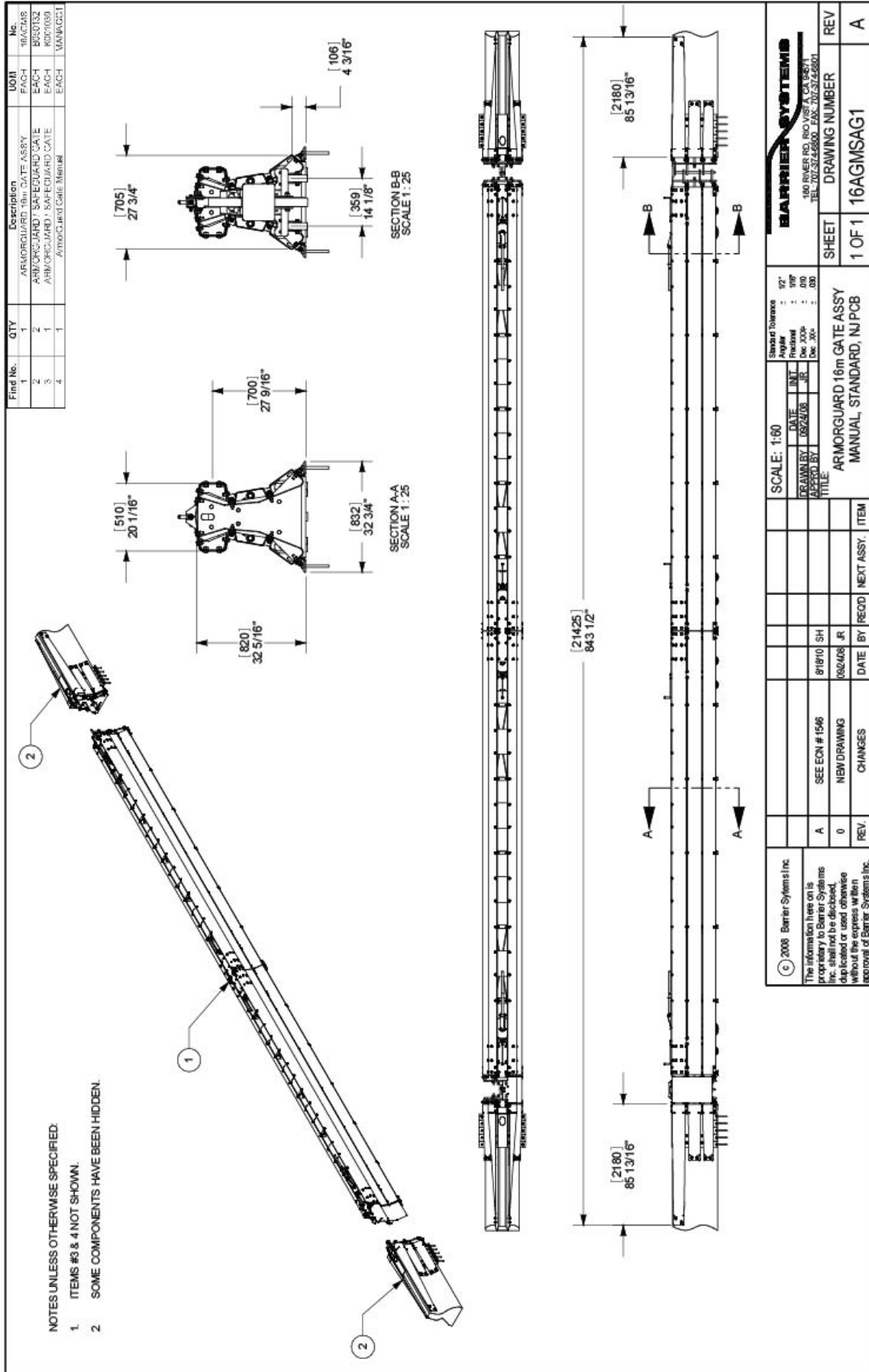

Part No.	QTY	Description	UOM	Kit No.
1	1	ARMORGUARD 16m GATE ASSY	EACH	16AGMSAG1
2	2	ARMORGUARD 16m STANDARD GATE	EACH	16AGMSAG1
3	2	ARMORGUARD 16m STANDARD GATE	EACH	16AGMSAG1
4	1	ARMORGUARD 16m GATE MANUAL	EACH	16AGMSAG1

SCALE: 1:50		Standard Tolerance	
DATE	BY	APPROVAL	DATE
08/24/08	JR		
DRAWN BY		APPROVED BY	
TITLE: ARMORGUARD 16m GATE ASSY MANUAL, STANDARD, N/PCB			
REV	CHANGES	DATE	BY
0	NEW DRAWING	08/24/08	JR
1	SEE ECH # 1546	01/18/10	SH
2			
3			
4			
5			
6			
7			
8			
9			
10			
11			
12			
13			
14			
15			
16			
17			
18			
19			
20			
21			
22			
23			
24			
25			
26			
27			
28			
29			
30			
31			
32			
33			
34			
35			
36			
37			
38			
39			
40			
41			
42			
43			
44			
45			
46			
47			
48			
49			
50			
51			
52			
53			
54			
55			
56			
57			
58			
59			
60			
61			
62			
63			
64			
65			
66			
67			
68			
69			
70			
71			
72			
73			
74			
75			
76			
77			
78			
79			
80			
81			
82			
83			
84			
85			
86			
87			
88			
89			
90			
91			
92			
93			
94			
95			
96			
97			
98			
99			
100			

**Barrier Systems Inc.**  
 160 BAKER RD. BOCA RATON, FL 33433  
 TEL: 702.374.6800 FAX: 702.374.6801

ARMORGUARD 16m GATE ASSY  
 MANUAL, STANDARD, N/PCB

1 OF 1 16AGMSAG1



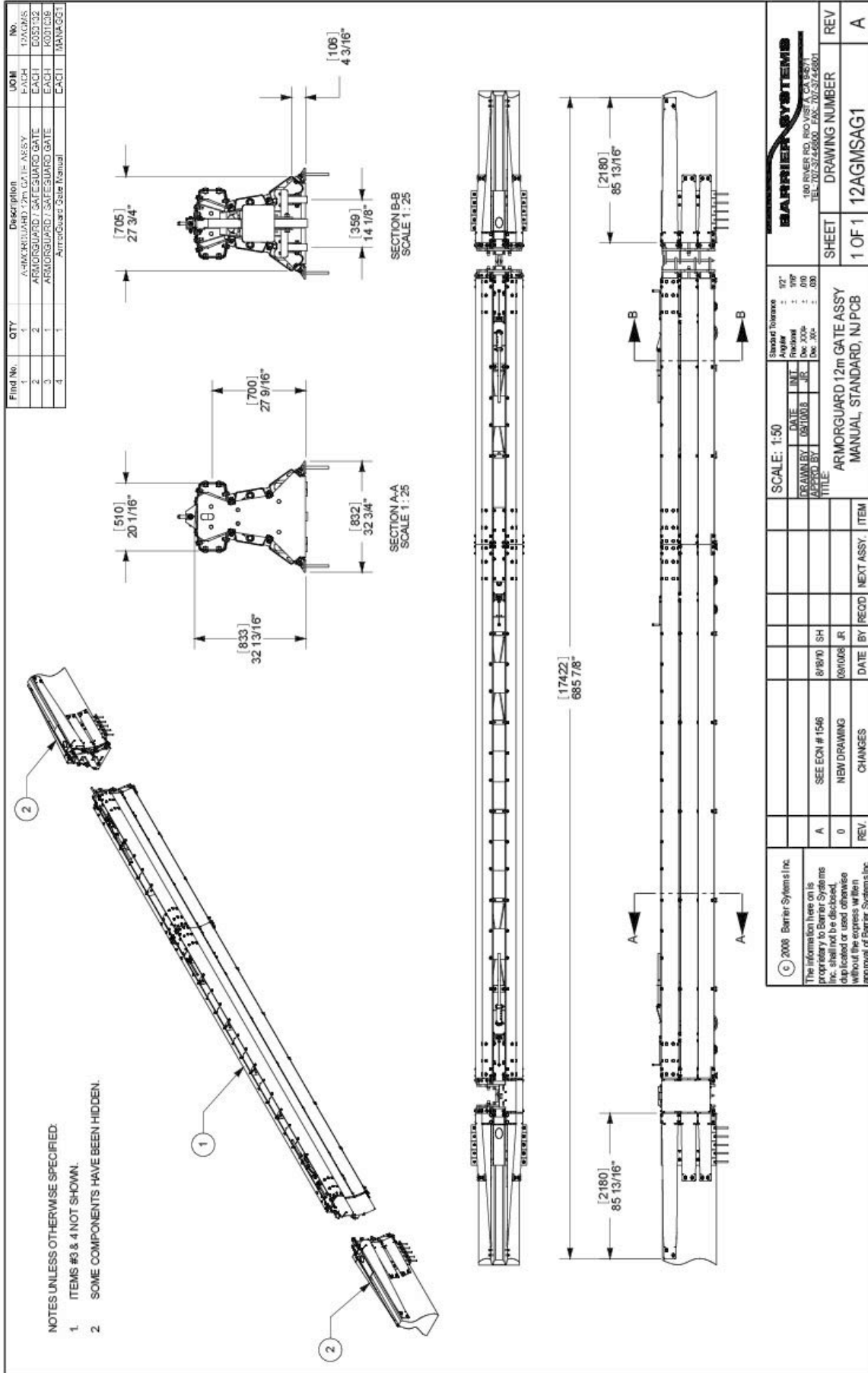

Find No.	QTY	Description	UOM	No.
1	1	ARMORGUARD 12m GATE ASSY	EACH	12AGMS
2	2	ARMORGUARD SAFEGUARD GATE	EACH	EGS332
3	1	ARMORGUARD SAFEGUARD GATE	EACH	R01016
4	1	ArmorGuard Gate Manual	EACH	MANAGC1

SCALE: 1:50 Standard Deviance : 1/2" Angular : 1/8" Fractional : 1/16" Decimals : 0.00 Decimals : 0.00		<b>ARMORGUARD SYSTEMS</b> 180 RIVER RD. RIO Vista, CA 94741 TEL: 707-374-6800 FAX: 707-374-6801	
DRAWN BY: DJR CHECKED BY: JR DATE: 08/10/08	SEE ECN # 1546 NEW DRAWING	ARMORGUARD 12m GATE ASSY MANUAL, STANDARD, NJ PCB	SHEET: 1 OF 1 DRAWING NUMBER: 12AGMSAG1 REV: A
REV: 0 DATE: 08/10/08 BY: JR	CHANGES	RECORD NEXT ASSY:	ITEM
© 2008 Barrier Systems Inc. The information here on is proprietary to Barrier Systems Inc. shall not be disclosed, duplicated or used otherwise without the express written approval of Barrier Systems Inc.			

# INSTALLATION AND MAINTENANCE MANUAL

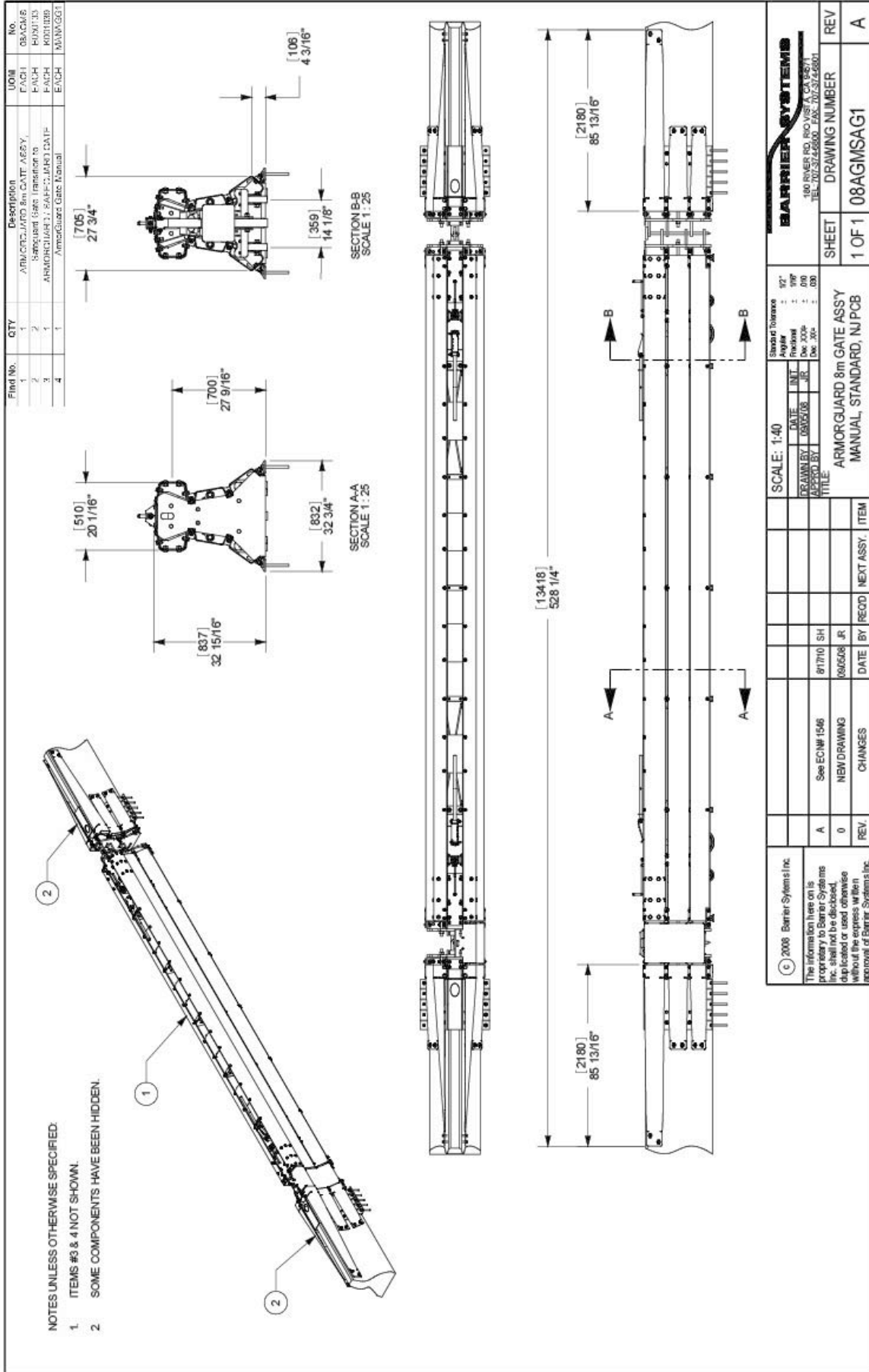

**NOTES:**

- ITEMS 19-22 NOT SHOWN.
- USE 8 OF ITEM 13 & 14 AND 16 OF ITEM 15 TO MOUNT ITEMS 19-22.

Item	Qty	Part Description	Part#	UM
1	1.00	Sig Top Panel End Cap Right	B020510	EACH
2	1.00	Sig Top Panel End Cap Left	B020511	EACH
3	1.00	Sig Hinge Mount Shear Plate Ad	B020513	EACH
4	4.00	Sig Upper Mount Strip Adjustab	B020514	EACH
5	2.00	Sig Bottom Mount Strip Adjustab	B020515	EACH
6	4.00	Sig Threaded Backing Plate Dism	B020703	EACH
7	12.00	Round Rod 5/8-11x1 L 4.0	4001115	EACH
8	12.00	Sig Riv W/In Round Rod Sbs	A020718	EACH
9	12.00	Round Nut Receiver 5/8-11	4001116	EACH
10	28.00	C-SKR BH 5/8-11x2.02 Gal	2001205	EACH
11	48.00	W/In 5/8 Flat Steel Gal	2001118	EACH
12	22.00	Flat BS 5/8-11 A 50 Q2 Gal	2001154	EACH
13	14.00	C-SKR BH 3/4-10x2.7 A 325 Gal	2001208	EACH
14	14.00	HS Nut 3/4-10 H V Q2 Gal	2001509	EACH
15	14.00	W/In 3/4 Flat Gal Rd Steel G	2001580	EACH
16	2.00	Sig Threaded Connecting Rod Dsb	B020226	EACH
17	4.00	HS Nut 1/8 Gal	2001404	EACH
18	1.00	Sig Top Adjustment Pin	B020540	EACH
19	1.00	Top Adjustment Leg	B020541	EACH
20	1.00	Top Adjustment Leg	B020542	EACH
21	1.00	Sig Mid Leg rev "A"	B020543	EACH
22	1.00	Sig Btm Adjustment Leg	B020545	EACH

**SCALE:** 1:12

**DRAWN BY:** 5/12/05 **INT:** CMB **Dec:** XXXX +.010

**DATE:** 5/12/05 **CMB:** GAD **Dec:** XXX +.030

**TITLE:** HINGE MOUNT SET  
ARMORGUARD / SAFEGUARD

REV.	CHANGED TITLE	DATE	BY	RECD	ITEM
E	SEE ECN 00684	9/5/08	JR		
D	SEE ECN 00684	10/4/05	CMB		
C	SEE ECN 00664	5/25/05	CMB		
REV.	CHANGES	DATE	BY	RECD	ITEM

© 2005 Barrier Systems Inc.  
The information herein is proprietary to Barrier Systems Inc. shall not be disclosed, duplicated or used otherwise without the express written approval of Barrier Systems Inc.

**MODEL:** B010342

**DRAWING NUMBER:** B010342

**REV:** E

# INSTALLATION AND MAINTENANCE MANUAL

Item	Qty	Part Description	Part#	UM
1	2/00	SF, Top Panel Connecting Bracket	B020609	EACH
2	1/00	SF, Coupling Shear Plate	B020612	EACH
3	4/00	SF, Coupling Strap Top (R/L) (40)	B020901	EACH
4	2/00	SF, Coupling Strap Bottom (R/L)	B020902	EACH
5	2/00	SF, Threaded Connecting Rod (R)	B020903	EACH
6	4/00	W, Bar 1/2" x 1/8" (40)	2901428	EACH
7	4/00	W, Bar 1/2" x 1/8" (40)	2901429	EACH
8	8/00	SF, Threaded Backstop Plate (Pam)	B020905	EACH
9	2/00	Channel Bolt 5/8" x 1 1/4" (2)	4001115	EACH
10	2/00	SF, R/W Shear Guard Bolt (S)	A020718	EACH
11	2/00	Channel Nut (R/L) 5/8" x 1 1/2" (2)	4001116	EACH
12	52/00	C-SF/R/L Bolt 5/8" x 1 1/2" (2) Gal	2001205	EACH
13	44/00	Nut (R/L) 5/8" x 1 1/2" (2) Gal	2001204	EACH
14	90/00	W, Bar 5/8" x 1/4" Shear (Gal)	2001118	EACH

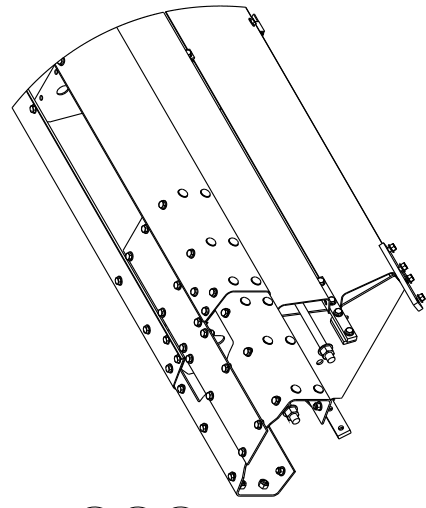
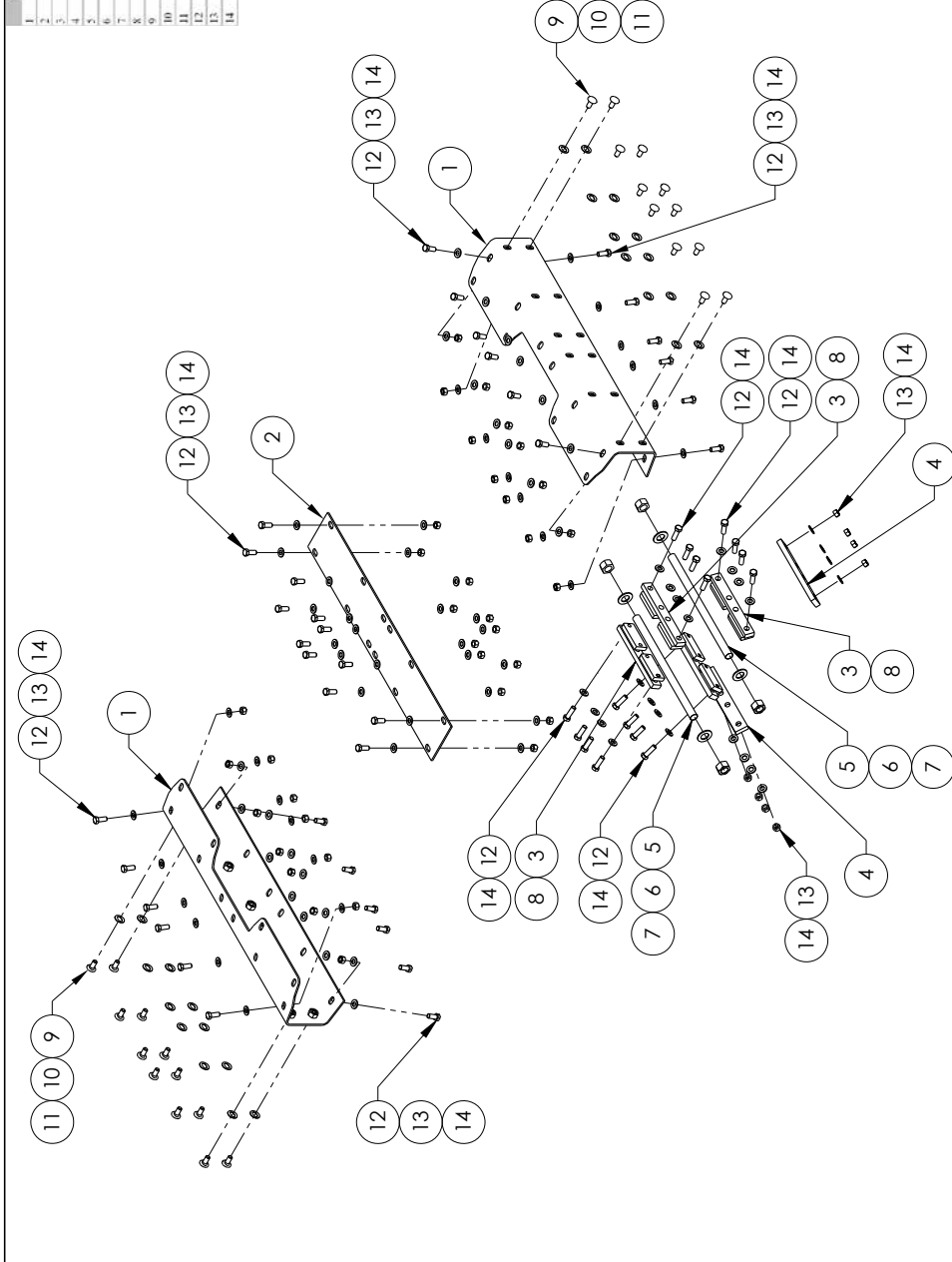

© 2005 Barrier Systems Inc.		Standard Tolerance All Dimensions in Inches Fractional +/- 1/16 Dec. XXX +/- .010 Dec. .XXX +/- .030	
SCALE: 1:16	DATE: 5/17/05	INTL: CMB	GAD
DRAWN BY: JR	10/22/08	CHANGED TITLE	REV. D
DATE: 5/25/05	CMB	SEE ECN 00664	REV. C
DATE: CHANGES	RECD	BY: DATE	ITEM
REV. D	CHANGES	DATE: 5/25/05	ITEM
REV. C	CHANGES	DATE: 10/22/08	ITEM
REV. D	CHANGES	DATE: 5/17/05	ITEM
TITLE: COUPLING SET, 4 METER SECTION, ARMORGUARD / SAFEGUARD		MODEL:	DRAWING NUMBER: B010343
REV. D		MODEL:	DRAWING NUMBER: B010343

Item	Qty	Description	Part #	U/M
1	1	Sfg. Transition Housing	B010539	EACH
2	1	Adapter Mount, Weldment, Sfg.	B010356	EACH
3	1	End Support, Safeguard	B011228	EACH
4	2	Sfg. Top Transition Panel	B020651	EACH
5	2	Sfg. Mid Transition Panel	B020709	EACH
6	2	Sfg. Bottom Transition Panel	B020706	EACH
7	6	C-Scr. HH 3/4-10x2 3/4 A325 Galv	2001398	EACH
8	6	Nut HH 3/4-10 HVV A563 Galv	2001399	EACH
9	12	Wsh. 3/4 F436 Flat Rd. Strukt	2001380	EACH
10	4	C-Scr HH 5/8-11x2 G2 Gal	2001205	EACH
11	4	Wsh. 5/8 F436 Struct. Galv	2000118	EACH
12	4	Guardrail Bolt 5/8 11x 1 1/4	4001115	EACH
13	4	Guardrail Nut Recessed 5/8-11	4001116	EACH
14	4	Sfg. Rd. Wsh. Guardrail Bolt	A020718	EACH

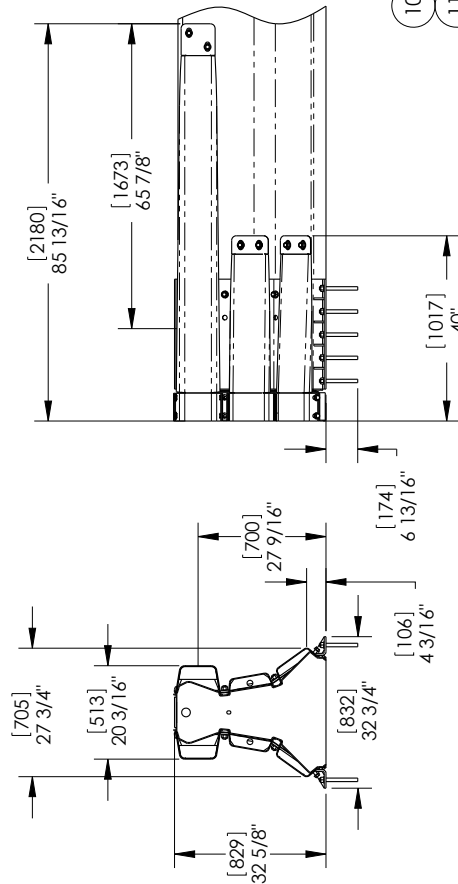
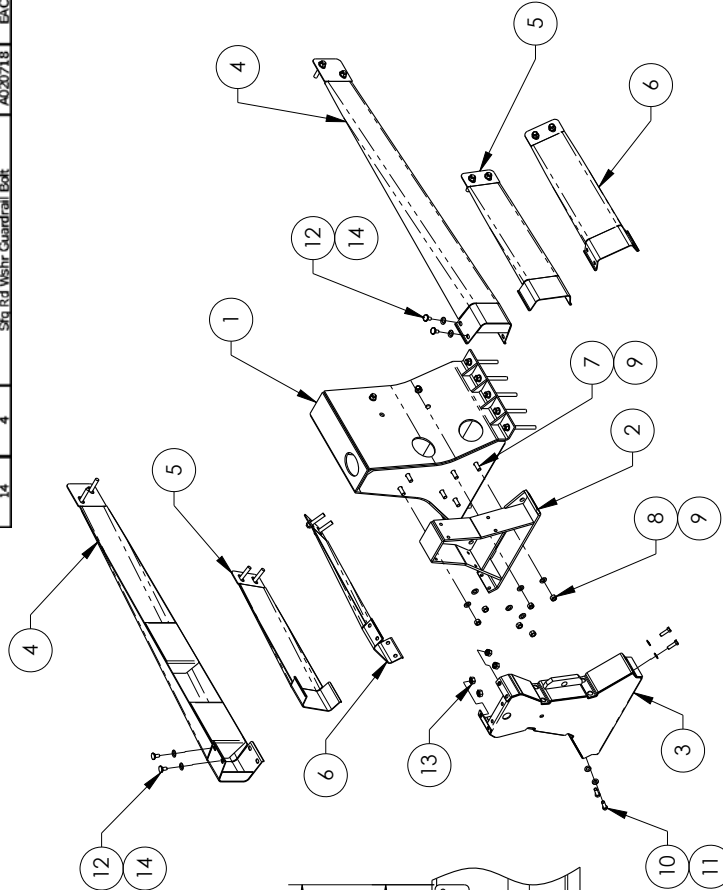
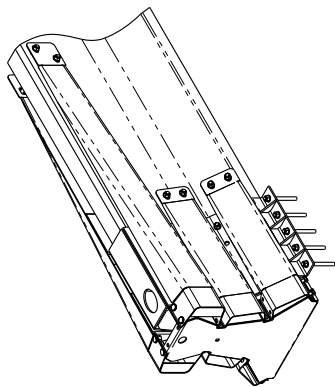

SCALE: 1:24 DRAWN BY: 5/23/05 DATE: 5/23/05 INIT: CMB CAD: GAD		Standard Tolerance Angular: ±.12 Deg. Linear: .005 Dec: XXXE+/- 010 Dec: XXE+/- .030
© 2005 Barrier Systems Inc. The information herein is proprietary to Barrier Systems Inc. and shall not be disclosed, duplicated or used otherwise without the express written approval of Barrier Systems Inc.	SEE ECN 00664 CHANGES	REV. C DATE BY RECD BY ITEM 5/23/05 CMB DATE BY RECD BY ITEM
TITLE:	SFG TRANSITION COMPONENTS, NJ PCB-STD.	
MODEL:	B010406	
DRAWING NUMBER:		REV. C



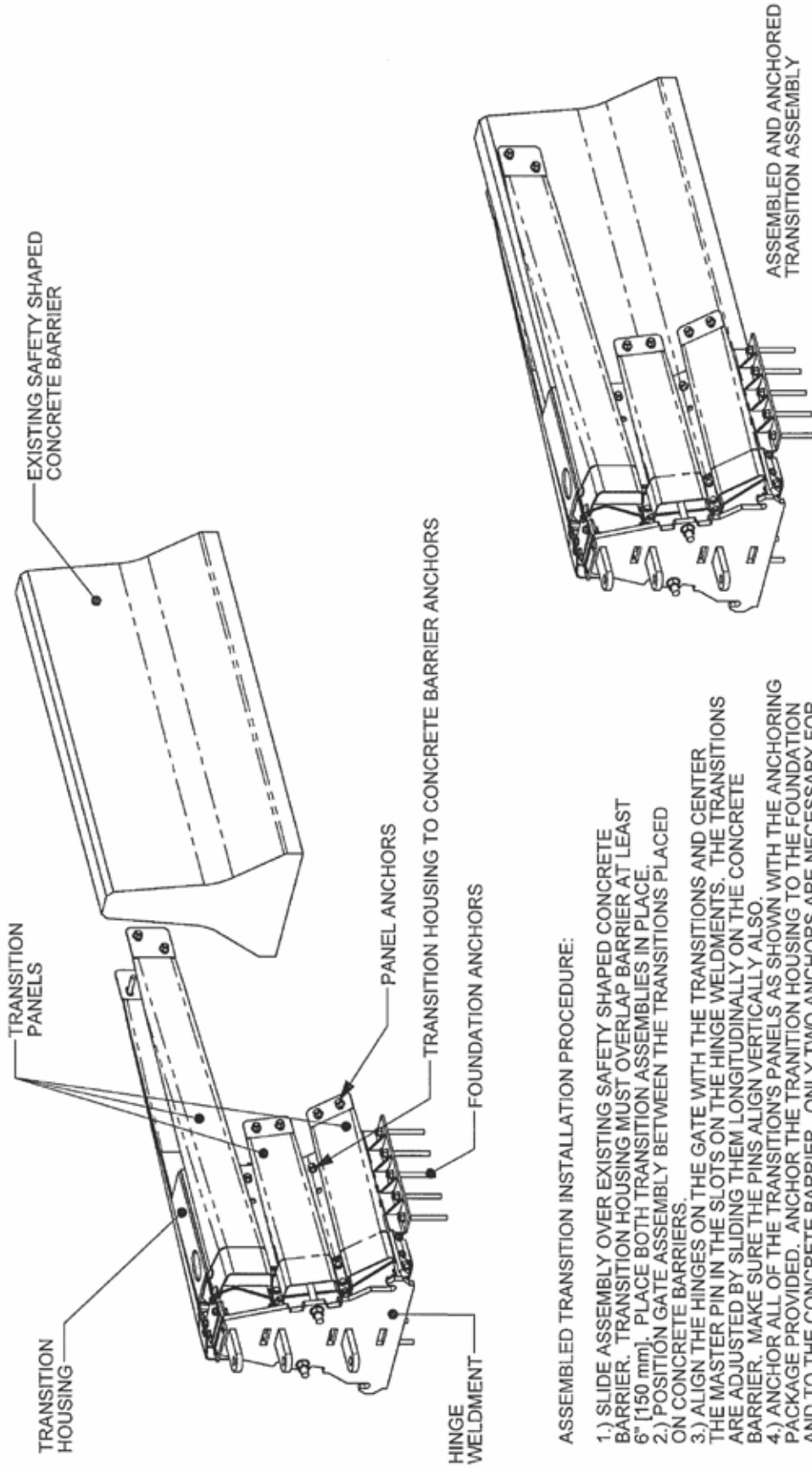

**ASSEMBLED TRANSITION INSTALLATION PROCEDURE:**

- 1.) SLIDE ASSEMBLY OVER EXISTING SAFETY SHAPED CONCRETE BARRIER. TRANSITION HOUSING MUST OVERLAP BARRIER AT LEAST 6" (150 mm). PLACE BOTH TRANSITION ASSEMBLIES IN PLACE.
- 2.) POSITION GATE ASSEMBLY BETWEEN THE TRANSITIONS PLACED ON CONCRETE BARRIERS.
- 3.) ALIGN THE HINGES ON THE GATE WITH THE TRANSITIONS AND CENTER THE MASTER PIN IN THE SLOTS ON THE HINGE WELDMENTS. THE TRANSITIONS ARE ADJUSTED BY SLIDING THEM LONGITUDINALLY ON THE CONCRETE BARRIER. MAKE SURE THE PINS ALIGN VERTICALLY ALSO.
- 4.) ANCHOR ALL OF THE TRANSITION'S PANELS AS SHOWN WITH THE ANCHORING PACKAGE PROVIDED. ANCHOR THE TRANSITION HOUSING TO THE FOUNDATION AND TO THE CONCRETE BARRIER. ONLY TWO ANCHORS ARE NECESSARY FOR ANCHORING THE TRANSITION HOUSING TO THE CONCRETE BARRIER PER SIDE.
- 5.) THE HINGE ATTACHMENT HARDWARE PROVIDE ADDITIONAL ADJUSTMENTS AFTER THE TRANSITION IS ANCHORED IF NECESSARY.

SCALE: 1:25

DATE	INIT.	Standard Tolerance
3/19/07	GAD	Angular ± 1/2°
		Fractional ± 1/16"
		Dec .XXX± ± .010
		Dec .XX± ± .000

TITLE:  
TRANSITION INSTALLATION INSTRUCTIONS,  
ASSEMBLED TRANSITION, SG-GATE

**BARRIER SYSTEMS INC**

180 RIVER RD, RIO VISTA, CA 94571  
TEL: 707-374-6800 FAX: 707-374-6801

SHEET	DRAWING NUMBER	REV.
1 OF 1	INSTALLATION DOC	

REV.	CHANGES	DATE	BY	REQ'D	NEXT ASSY.	ITEM



## **APPENDIX D**

### **Maintenance**

#### **Periodic Maintenance**

The ArmorGuard Barrier System has been designed to minimize the need for periodic maintenance. The only periodic maintenance items that need to be addressed are as follows:

- Apply grease (Chevron EP NLGI 2 grease or equivalent) to the zerk fittings on the caster wheels at least annually.

### **General Inspection and Maintenance**

#### **Drive-by Inspection**

Drive-by type inspections should be performed at least monthly. The purpose of the drive-by inspection is to observe for the following characteristics:

- Any evidence of vehicle impacts.
- Structural damage.
- Loose or out of place components.
- Excessive debris build-up that would not allow the system to be operated.

If any of these conditions are observed, a walk-up inspection is required.

#### **Walk-up Inspections**

Walk-up inspections should be conducted at least annually and whenever deemed appropriate from a drive-by inspection. A walk-up inspection should consist of the following items:

- Structural components – Conduct an inspection of all structural assemblies to ensure that all components are structurally sound, properly connected and there are no loose fasteners or damaged components. The hinge pins should be in position and free to move and the hinge covers properly fitted and connected. Any components observed to be nonconforming to the manufacturer's drawings should be replaced or repaired.
- Operating systems – Raise, hold, and lower the system in accordance with the operating instructions and ensure that the hinge covers, hinge pins, casters and other functional components operate in the proper manner. Any components observed to be deficient should be repaired or replaced in accordance with the manufacturer's instructions.
- General cleaning – The area around and within the internal and external operating area should be kept free of debris that could affect either the impact performance or restrict the ability to open or close the system when needed.

### **For additional information regarding this product, please contact:**

Lindsay Transportation Solutions  
Sales and Service, Inc.  
180 River Road  
Rio Vista, CA 94571

U.S. Toll Free (888) 800-3691  
Phone: (402) 829-6800  
Fax: (707) 374-6801



**DISTRIBUTED BY:**



Barrier Systems by Lindsay

18135 Burke St., Elkhorn, NE 68022 • U.S. Toll Free: (866) 404-5049 • [www.lindsaytransportationsolutions.com](http://www.lindsaytransportationsolutions.com)

Installation manual for the ArmorGuard system is subject to change without notice to reflect improvements and upgrades. Please contact Barrier Systems by Lindsay to confirm that you are using the most current installation manual and instructions.

Additional information is available from Barrier Systems by Lindsay. © Barrier Systems by Lindsay